

Open Frame Type Switching Power Supply

FEATURES

- Medical 60601-1 3rd Edition approved
- U-Channel, End fan and Top fan types available
- Optional high efficiency OR-ing FET diode Current share function
- 2 year warranty

ELECTRICAL SPECIFICATIONS

- Input range : 90-264VAC
- Frequency : 47 - 63Hz
- Power Factor : > 0.95 @ 115VAC; > 0.90 @ 230VAC @ full load
- Inrush current : < 25A peak @ 115VAC; < 50A peak @ 230VAC cold start @ 25°C
- Input current (rms) : 4.5A @ 115VAC; 2.25A @ 230VAC max.
- Efficiency : > 83% typical @ full load, 115VAC
- Leakage current : < 300uA @ 264VAC
- Maximum power : 360 Watts with 30CFM forced air cooling (U-channel type)
- Hold-up time : > 20ms typical @ 360 watt load, 115VAC
- Short circuit protection : Auto recovery
- Over load protection : 110% to 150% maximum rating, Auto-recovery
- Over voltage protection : 130% max. above nominal output, shutdown and latch off
- Current share (Single wire) : Up to 4 units can be paralleled [Optional] within 10% accuracy at full load.
- Remote inhibit function
- +5VSB/0.25A convection cooling, 1.0A forced air cooling
- +12V/1A DC fan Output

ENVIRONMENTAL

- Operating temperature : 0 to +70°C (Refer to derate curve on the last page)
- Storage temperature: -20°C to +85°C
- Humidity: Non-condensing 0% to 90%
- MTBF : > 100,000 hours @ full load and 25°C ambient temperature

DC OUTPUT & FEATURES

Model No. (Note 1)	Output Voltage	Minimum Load	Maximum Load Convection (Note 2)	Maximum Load (Note 3)	Output Watts	O/P Regulation (Note 4)	Ripple & Noise(Vp-p) (Note 5)
PW-M360B-1Y120-X (D)	+12V	0A	22.5A	30A	360W	±1%	120mV
PW-M360B-1Y240-X (D)	+24V	0A	11.25A	15A	360W	±1%	240mV
PW-M360B-1Y300-X (D)	+30V	0A	9A	12A	360W	±1%	300mV
PW-M360B-1Y360-X (D)	+36V	0A	7.5A	10A	360W	±1%	360mV
PW-M360B-1Y480-X (D)	+48V	0A	5.63A	7.5A	360W	±1%	480mV
PW-M360B-1Y540-X (D)	+54V	0A	5.01A	6.67A	360W	±1%	540mV
PW-M360B-1Y570-X (D)	+57V	0A	4.74A	6.32A	360W	±1%	570mV

- Note:**
- Option: X=U, U-Channel, X=S, End Fan, X=T, Fan on top; D=Current share
 - Option U, max output 270W @ +40°C ambient max.
 - Option U: max output 360W force air 30CFM cooling, Option S and T: max output 360W, +50°C ambient max.
 - At 25°C including initial tolerance, line voltage, load currents and output voltages adjusted to factory settings.
 - Ripple and noise are measured at oscilloscope 20MHz bandwidth by a 10uF electrolytic capacitor and a 0.1uF ceramic capacitor in parallel at output connector.



RoHS compliant

U-channel type

Dimension : L203.2 × W118.5 × H42.0 mm (8" × 4.66" × 1.65")

Weight : 0.86 kgs. (1.90 lbs.)

End Fan type (40x40x20mm DC Fan)

Dimension : L229.4 × W118.5 × H43.0 mm (9.03" × 4.66" × 1.69")

Weight : 0.98 kgs. (2.16 lbs.)

Top Fan type (60x60x15mm DC Fan)

Dimension : L203.2 × W118.5 × H66 mm (8" × 4.66" × 2.60")

Weight : 0.99 kgs. (2.18 lbs.)

SAFETY STANDARDS

UL60601-1 3rd Edition

CSA-C22.2 No.60601-1 3rd Edition

EN60601-1 3rd Edition

IEC EN60601-1 3rd Edition

EMC STANDARDS

EN60601-1-2

FCC Part 18 Class B

EN55011 Class B

CE

Open Frame Type Switching Power Supply

MECHANICAL SPECIFICATION

Option : U, U-Channel

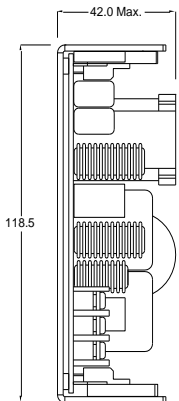
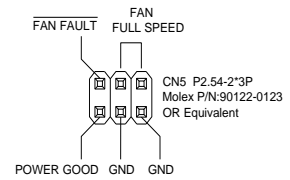
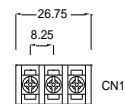
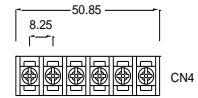
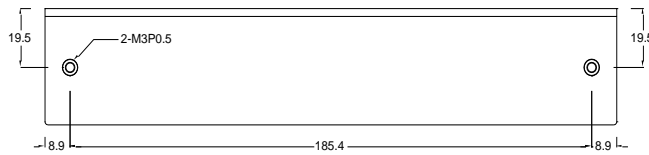
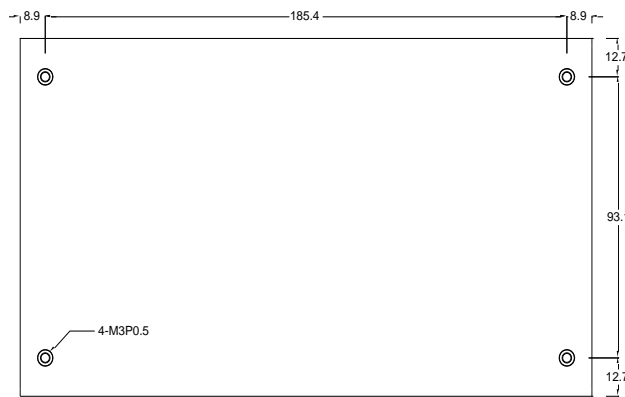

Recommended direction for force airflow

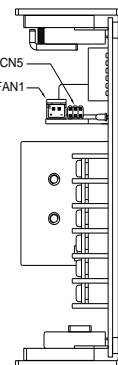
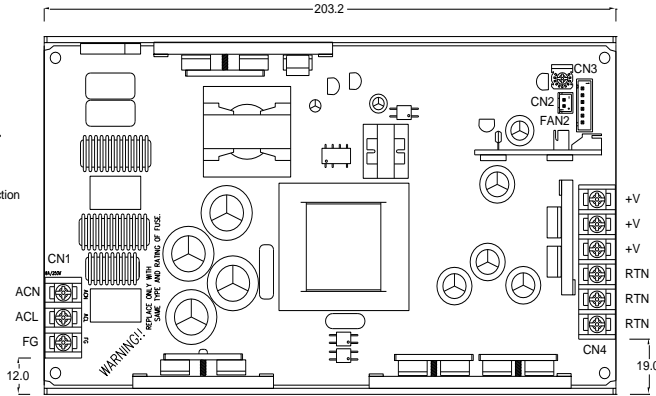

Open Frame Type Switching Power Supply

MECHANICAL SPECIFICATION

Option : S, End Fan

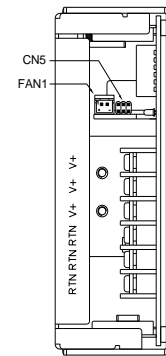
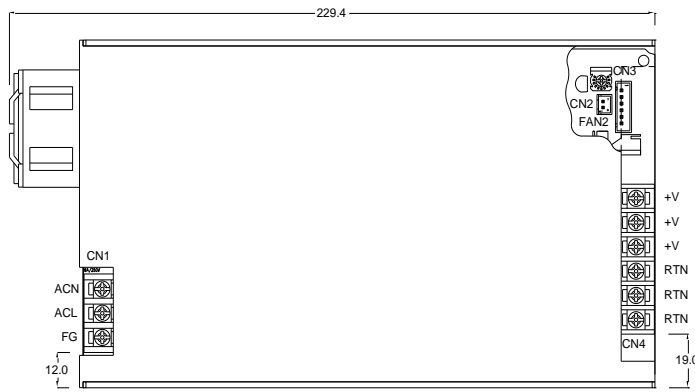
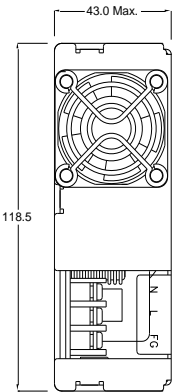
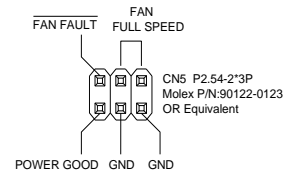
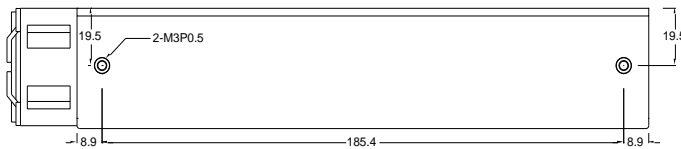
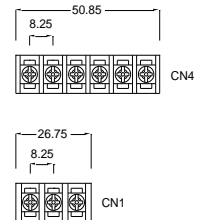
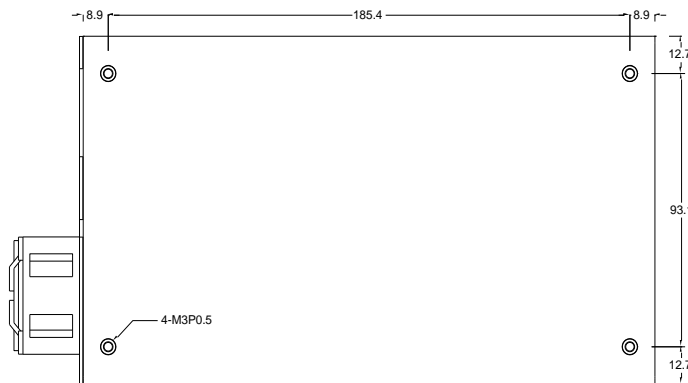
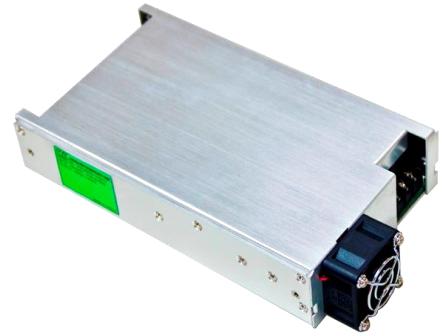

Open Frame Type Switching Power Supply

MECHANICAL SPECIFICATION

Option : T, Fan on top

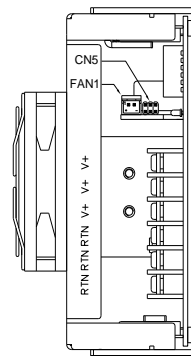
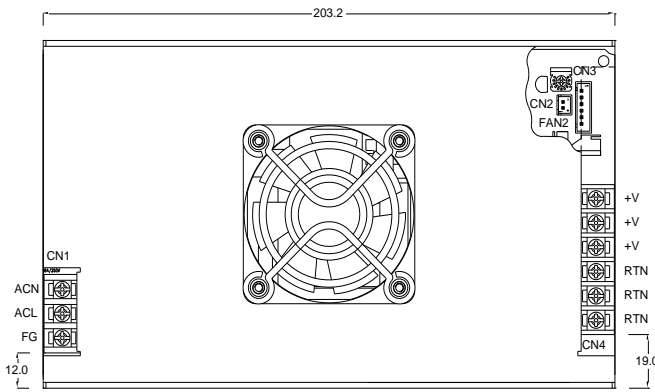
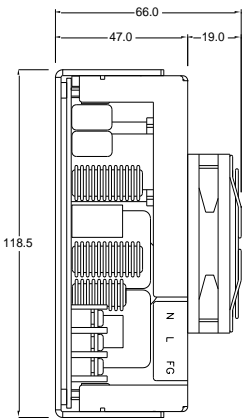
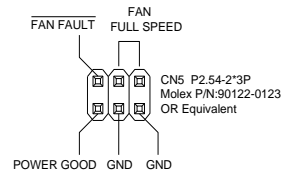
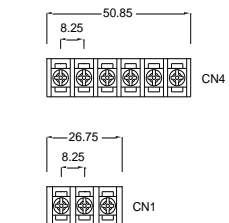
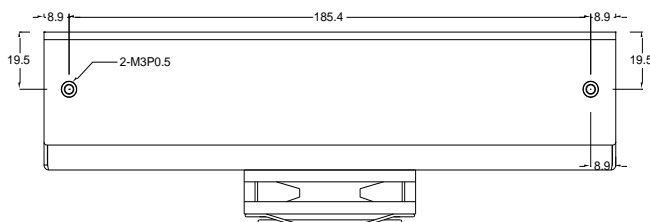
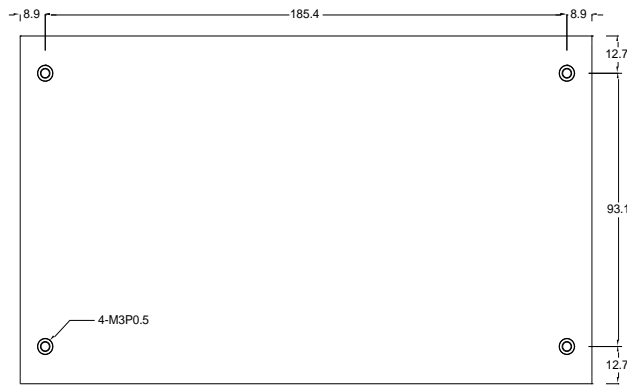

Open Frame Type Switching Power Supply

MECHANICAL SPECIFICATION

MATCHING CONNECTORS

CN1: Input Connector

3-Pole Terminal block pitch: 8.25mm rate 20A/300V

Pin #	Signal
1	AC Neutral
2	AC Line
3	F.G.

CN2: +5VSB Output Connector

JST B2B-XH-A pitch:2.5mm or equivalent, mates with female housing JST XHP-2 or equivalent

Pin #	Signal
1	+5VSB
2	GND

CN3: Remote Sense Connector

JST B6B-XH-A pitch: 2.5mm or equivalent, mates with female housing JST XHP-6 or equivalent

Pin #	Signal
1	Sense +
2	Sense -
3	+5VSB
4	GND
5	INHIBIT (Remote control)
6	Current Share

INHIBIT: Logic level HIGH(+5V): Enable, Logic level LOW: Disable(0V)

CN4: Main Output Connector

6-Pole Terminal block pitch: 8.25mm rate 20A/300V

Pin #	Signal
1	+Vo
2	+Vo
3	+Vo
4	RTN
5	RTN
6	RTN

FAN1: Fan Output Connector

JST S2B-XH-A pitch: 2.5mm or equivalent, mates with female housing JST XHP-2 or equivalent

Pin #	Signal
1	+12VDC FAN+
2	+12VDC FAN-

FAN2: Fan Output Connector

JST B2B-XH-A pitch: 2.5mm or equivalent, mates with female housing JST XHP-2 or equivalent

Pin #	Signal
1	+12VDC FAN+
2	+12VDC FAN-

Open Frame Type Switching Power Supply

MECHANICAL SPECIFICATION

CN5: Fan control & Power Good Signal Connector

JST RF-H062TD-1130 pitch: 2.54mm or equivalent, mates with female housing JST RF-06 or equivalent

Pin #	Signal
1	FAN FAULT
2, 3	FAN FULL SPEED
4	POWER GOOD
5	GND
6	GND

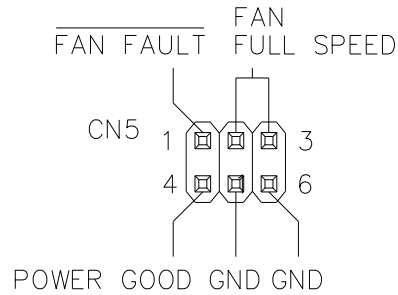

FAN FAULT: Fan status indication, Fan Good: Logic level HIGH(+5V), Fan Fault: Logic level LOW(0V)

FAN FULL SPEED: Short these 2 pins (#2 and #3) with mini-jumper to get highest fan speed

POWER GOOD: Power Good: Logic level HIGH(+5V), Power Fault: Logic LOW(0V)

DERATING CURVE

